

Article number: 20478B20M8ELS

Description: E+G Clamp mounting - GN 478-B20-M8-ELS

Measures

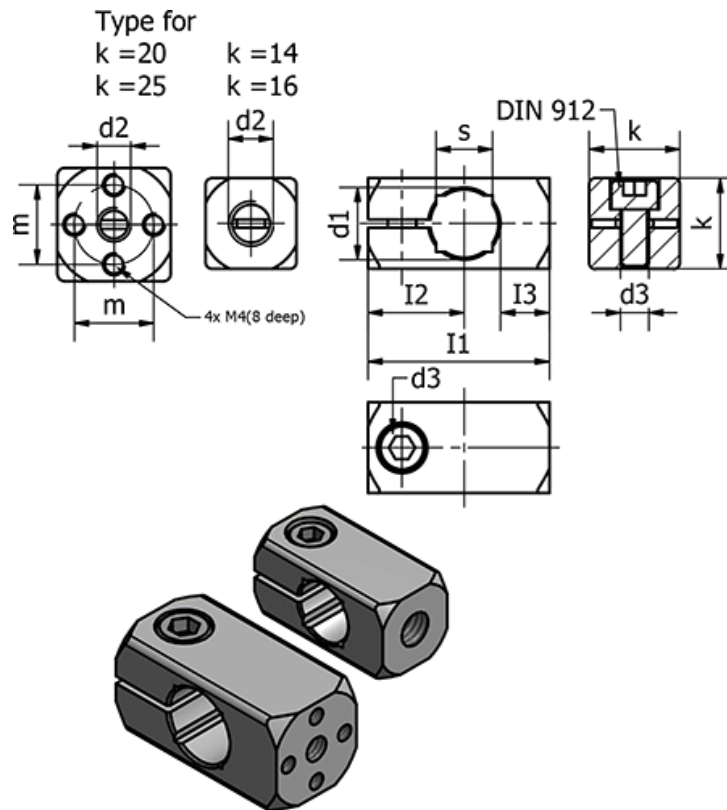

Clamping kit for $d_2 =$ GN 511-M6-25	m	$= 17$	
d_1 h11	$= 20$	s	$= 16$
d_2	$= M8$	Weight (g)	$= 51$
d_3	$= M6$		
I_1	$= 45$		
I_2	$= 21.5$		
I_3	$= 12$		
k	$= 25$		